



FLOJET[®]

Agriculture Pumps and Accessories



ITT

Engineered for life



To access our 24 Hour Technical Data Assistance Via Fax, Call (800) 337-4083
For DFAX #1000 series and (800) 297-3904 for DFAX #2000 series

Simply enter the Docufax number (under the DFAX# column) shown opposite the product model number and instantly receive by fax the technical data sheet you requested - Day or Night!
Use 9-digit numbers on all purchase orders and communication.



Series	Page No.	DFAX #	Description	Data Sheet No.
11810 Series	16	1001	Bronze Utility Pump	43000-0068
16400	21	1014	Series Pump Tube Poly	43000-0572
16410	21	1015	Series Pump Tube SS	43000-0573
16450	21	1019	Drum Pump Motor	43000-0707
16510	21	1020	Series Pump Tube Hyg SS	43000-0585
16520	21	1021	Series Pump Tube Kynar	43000-0586
17860	22	1033	Oil and Fluids Changing System	950-0095
17830-1012	14	1031	DC Water Puppy Reversible	43000-0708
18590	18	1043	Extended Run Dry DC Macerator	43000-0745
18660 Series	14	1053	DC Water Puppy	43000-0737
18670 Series	15	1054	Commercial Duty Water Puppy	43000-0738
18690	18	1058	Macerator AC	43000-0186
23920 Series	17	1284	Extended Run Dry DC Flex Pump	43001-0511
30140	17	1115	Extended Run Dry AC Flex Pump	43000-0693
30180	17	1116	Extended Run Dry AC Flex Pump	43000-0694
4100-521	9	2040	Quad Commercial Duty	81000-351
4100-xxx	10	2035	Quad Standard Duty	81000-176
4300-529	9	2096	Quad AC Commercial Duty	81000-350
4300-530	9	2040	Quad Commercial Duty	81000-351
4300-xxx	10	2041	Quad Standard Duty	81000-084
5100	13	2050	Air Operated Diaphragm Pump	81000-131
59500	20	1255	Magnetic Drive Centrifugal	43001-0515
6050 Series	16	1260	Bronze Utility Pump	43000-0074
D21XX Series	4	2060	Duplex II Low Pressure Pumps	81000-338
D21XX Series	5	2061	Duplex II High Pressure Pumps	81000-339
G57	12	2069	Air Operated Diaphragm Pump	82000-014
JSP03, JSP07	19	1276	Sump Pump SS AC	43000-0765
LF & RLF Series	2	2073	LF Series Diaphragm Pumps	81000-312
R4400 Series	9	2039	Quad Variable Speed Drive	81000-352



Explosion hazard. Do not pump gasoline or other flammable liquids with any of the pumps shown in this catalog. Explosion and death can occur.

PRODUCT RATING: The data given in this catalog are approximate values based on the latest information available when this catalog was printed. English and metric performance data and dimensions are rounded to the approximate decimal point accuracy. Jabsco flexible impeller pumps, except motor pump units, are flow rated at 1750 RPM at 10 ft. (3m) of head. Unless otherwise noted, Jabsco flexible impeller motor pump units are rated at motor speed with 10 ft. (3m) of head. Centrifugal motor pump units are rated at 5 ft. (1.5m) of head. Manual pumps are rated in strokes/gallon with normal pumping action. Diaphragm motor pump units are flow rated at open flow. Blowers are rated at open flow. Searchlight bulb characteristics are taken from the latest bulb manufacturer's literature available.



CONTENTS

Electric Diaphragm Pumps

LF Series Pumps	(2 Piston)	2-3
Duplex II Series Pumps	(2 Piston)	4-5
Triplex Series Pumps	(3 Piston)	6
High Pressure Triplex Series Pumps	(3 Piston)	7
Quad Series Pumps	(4 Piston)	8-10
6000 Series Pumps	(5 Piston)	11

Air-Operated Diaphragm Pumps

G57 Series Pumps		12
5100 Series Pumps		13

Flexible Impeller Pumps

17830 Bronze Flex Pump DC Reversible		
18660 Bronze Flex Pump DC		14
18670 Bronze Flex Pump DC Commercial Duty		15
11810 Bronze Flex Pump AC Utility		
6050 Bronze Flex Pump AC Utility		16
23920 Bronze Flex Pump DC Extended Run Dry		
30140 Bronze Flex Pump AC Extended Run Dry		
30180 Bronze Flex Pump AC Extended Run Dry		17
18590 Macerator Run Dry DC		
18690 Macerator Run Dry AC		18

General Purpose Pumps

JSP Stainless Steel Centrifugal Sump Pumps		19
59500 Magnetic Drive Centrifugal Pumps		20
16450 Drum Pumps		21
17860 Oil and Fluids Changing System		22
Accessories & Fittings		23
Chemical Data		24
Product Specification Form		25



LF Series Pumps (2 Piston)



Far and away the best selling small pump in the industry. Choose from standard models or configure to meet the special needs of your OEM application. Long-life (2000 hours typical) motors have either a chemically resistant plastic housing or a metal finned housing for maximum motor cooling. Flojet's new demand switch plus bypass configuration provides optimum operation and extended cycle-life under any field condition.

OEM's appreciate features that save time and reduce cost. Features like built-in hose barb ports, flexible mounting feet, inline fuse, power connector, and manual on-off power switch.

Need a reliable demand switch? Then it has to be completely sealed! Flojet's one-piece welded body design with epoxy potted spade terminals keep reliability in and the elements out. No other switch in the industry meets these stringent design criteria.

SPECIFICATIONS

Pump Design	2 Chamber Diaphragm
Open Flow	1.0 gpm (3.8 lpm) high cam 0.7 gpm (2.7 lpm) low cam
Voltage	12V or 24 V DC
Body Material	Polypropylene
Diaphragm Material	Santoprene or Geolast
Check Valve Material	Viton or EPDM
Spring Material	316 Stainless Steel
Port Size	3/8" (9.5mm) Hose Barb
Motor	PMDC Ball Bearing type with internal fan
Recommended Fuse	5 amps for 12V models 3 amps for 24V models
Approvals	CE on RLF models
Maximum Pressure	35 psi (2.4 bar)
Duty Cycle at 70°F	Intermittent 30 psi (2.0 bar)
Liquid Temp	110°F (43°C) Maximum
Size	LF11 2.6" H x 3.5"w x 6.8"L (66 x 89 x 173 mm) LF12 2.3" H x 3.5"w x 6.2"L (58 x 89 x 157 mm)
Ship Wt.	LF11 1.9 lb (.9 kg) LF12 1.3 lb (.6 kg)

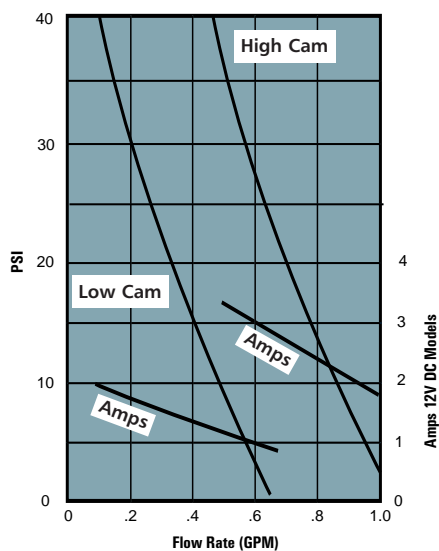

Electric Diaphragm Pumps



PUMP SPECIFICATIONS							PUMP FEATURES					
Mode	Supply Voltage	Diaphragm Material	Check Valve	Cam	Demand Switch	Bypass Pressure	Motor Housing	Manual on/off	Inline Fuse	Power Connector	Thermal Protection	Approvals
LF111421	12	Santo	Viton	LO	40	55	metal fins	Y	Y	Y	--	
LF121421	12	Santo	Viton	LO	40	55	plastic	--	--	--	Y	
LF112421	12	Santo	Viton	HI	40	55	metal fins	Y	Y	Y	--	
LF122421	12	Santo	Viton	HI	40	55	plastic	--	--	--	Y	
RLF111421	12	Santo	Viton	LO	40	55	metal fins	--	Y	Y	Y	CE
RLF121421	12	Santo	Viton	LO	40	55	plastic	--	--	--	Y	CE
RLF112421	12	Santo	Viton	HI	40	55	metal fins	--	Y	Y	Y	CE
RLF122421	12	Santo	Viton	HI	40	55	plastic	--	--	--	Y	CE
RLF112422	12	Santo	EPDM	LO	40	55	metal fins		Y	Y	Y	CE
LF111425	12	Geolast	Viton	LO	40	55	metal fins	Y	Y	Y	--	
LF122025	12	Geolast	Viton	HI	--	55	plastic	--	--	--	Y	
LF152421	12	Santo	Viton	HI	40	55	plastic	Y	Y	Y	--	
RLF222422	24	Santo	EPDM	HI	40	55	plastic	--	--	--	Y	CE
RLF222421	24	Santo	Viton	HI	40	55	plastic	--	--	--	Y	CE

Extended Life Motor
Smallest Tip Size
Best Dry Suction Lift
Best Open Flow gpm
Best Heat Dissipation
Best for Gentle Spray
Best For Stream Spray
Best For Chemicals
Best For Soap & Water
Best For Petroleum

LF111421	Y	02			x	x		x				
LF121421	Y	02				x		x				
LF112421	Y	06	x	x	x		x	x				
LF122421	Y	06	x	x			x	x				
RLF111421	Y	02			x	x		x				
RLF121421	Y	02				x		x				
RLF112421	Y	06	x	x	x		x	x				
RLF122421	Y	06	x	x			x	x				
RLF112422	Y	06	x	x	x		x		x			
LF111425	Y	02			x	x					x	
LF122025	Y	06	x	x			x				x	
LF152421	Y	06	x	x			x	x				
RLF222422	Y	06	x	x			x		x			
RLF222421	Y	06	x	x			x	x				

FLOJET®

Duplex II Series Pumps (2 Piston)



The Duplex II pump incorporates many new design innovations: half-spherical check valves for improved priming and efficiency, an external bypass system that is located outside of the pumping chamber, and the demand models feature a sealed pressure switch and back flow preventer to reduce pulsations.

Unique bypass system provides near-constant pressure to drive a wide range of nozzles for all your lawn, garden and agricultural spraying needs.

SPECIFICATIONS

Pump Design	2 Chamber Diaphragm
Open Flow	2.0 gpm (7.6 lpm) max.
Voltage	12V DC and 115V AC
Body Material	Polypropylene
Diaphragm Material	Santoprene, EPDM, Viton
Check Valve Material	Viton
Port Size	3/8" NPT(F)

Motor permanent magnet, totally enclosed non-vented

Maximum Pressure	90 psi (6 bar)
Duty Cycle	Intermittent
Suction Lift	Up to 8ft. (2.4m) vertical height
Liquid Temp	130°F (54°C) maximum

Size	100 & 80 psi demand pump
	7.6" x 3.24" x 3.63" (193 x 82 x 92 mm)
	70 psi bypass pump
	7.6" x 3.24" x 3.63" (193 x 82 x 92 mm)
Ship Wt.	60 psi demand pump
	8.0" x 3.31" x 3.26" (203 x 84 x 83 mm)
	4.5 lb. (2.0 kg) typical

Electric Diaphragm Pumps



FLOJET®

Demand Pump Performance

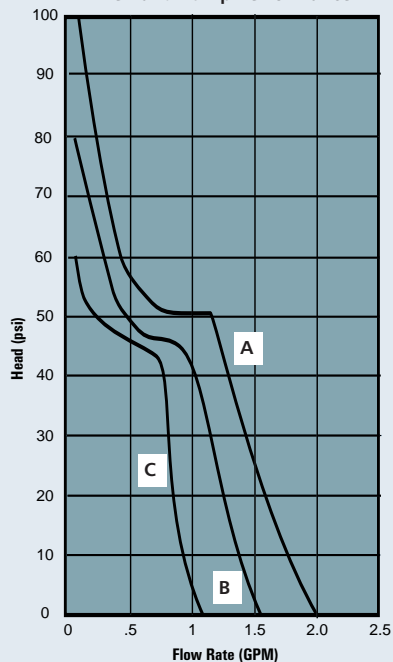

Bypass Pump Performance

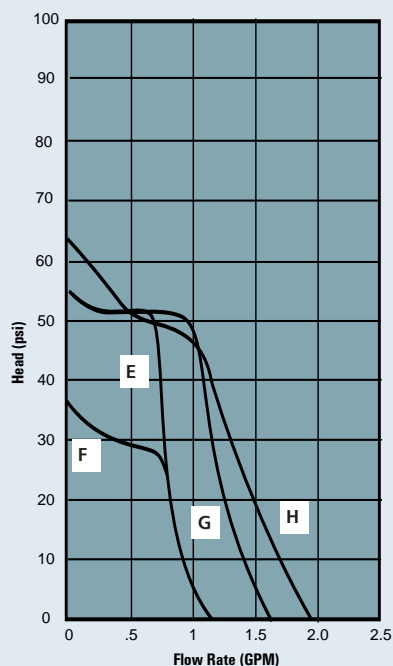

PUMP SPECIFICATIONS

Model	Supply Voltage	Diaphragm Material	Check Valve	Cam Angle	Demand Switch	Bypass Pressure	Motor Speed	Motor Length
D2135J7011	12V DC	EPDM	Viton	high	100 psi	--	high	med
D2125F6011	12V DC	Santo	Viton	med	80 psi	--	high	med
D2125F5011	12V DC	Santo	Viton	med	60 psi	--	high	med
D2135F5011	12V DC	Santo	Viton	high	60 psi	--	high	med
D2124F5011	12V DC	Santo	Viton	med	60 psi	--	high	short
D2121F5011	12V DC	Santo	Viton	med	60 psi	--	low	short
D2132F1311	12V DC	Santo	Viton	high	--	50 psi	low	med
D2135F1311	12V DC	Santo	Viton	high	--	50 psi	high	med
D2121F1311	12V DC	Santo	Viton	med	--	50 psi	low	short
D2121F1211	12V DC	Santo	Viton	med	--	30 psi	low	med
D3835V5011	115V AC	Viton	Viton	high	60 psi	--	high	med
D3835V1311	115V AC	Viton	Viton	high	--	50 psi	high	med
D21X005	12V DC	Santo	Viton	high	60 psi	--	high	short
D21X007	12V DC	Santo	Viton	high	--	50 psi	high	short

PUMP FEATURES

Model	Open Flow gpm	Flow Curve	Manual On/Off	Inline Fuse	Power Connection
D2135J7011	2.0	A	--	--	wires
D2125F6011	1.4	B	--	--	wires
D2125F5011	1.4	B	--	--	wires
D2135F5011	2.0	A	--	--	wires
D2124F5011	1.5	B	--	--	wires
D2121F5011	1.1	C	--	--	wires
D2132F1311	1.5	G	--	--	wires
D2135F1311	2.0	H	--	--	wires
D2121F1311	1.2	E	--	--	wires
D2121F1211	1.2	F	--	--	wires
D3835V5011	2.0	A	--	--	6' cord
D3835V1311	2.0	H	--	--	6' cord
D21X005	1.5	B	yes	--	2 pin plug
D21X007	2.0	H	--	--	2 pin plug

Triplex Series Pumps (3 Piston)



The Triplex Series pump was designed specifically for the Ag market. Flojet's new three chamber design and versatile fetures make it ideal for sprayers and many other transfer and dispensing applications.

This automatic demand pump comes with a sealed pressure switch and motor, is self-priming, can run dry, and can be installed in compact spaces.

SPECIFICATIONS

Pump Design	Motor Operated 3 Chamber diaphragm
Motor Design	Permanent Magnet TENV (non-ventillated)
Voltage	12 VDC, 115 VAC, 230 VAC
Cycles:	50/60 Hz
Amp Draw:	8 amp max for 12 VDC 0.65 amp max for 115 VAC
Pump Head:	Reinforced Polypropylene
Elastomers	Diaphragm Santoprene™ Check Valve EPDM or Viton
Max. Flow Rate:	2.0 GPM (7.6 LPM)
Maximum Pressure	50 psi (3.4bar)
Duty Cycle:	Intermittent
Weight	3.4 lb (1.5 Kg)
Certifications:	CE, NSF components
Port Size Inlet/outlet	3/8" NPTF

FLOW CURVE 12 VDC

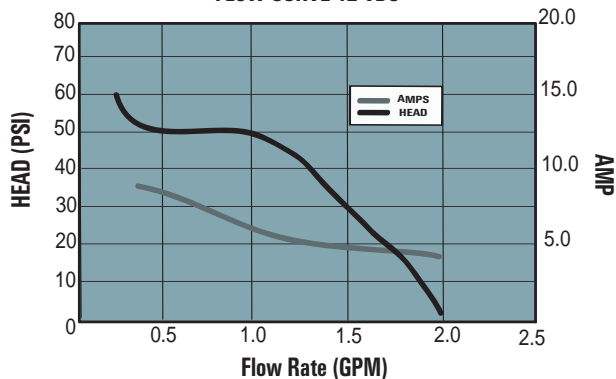

FLOW CURVE 115 VAC

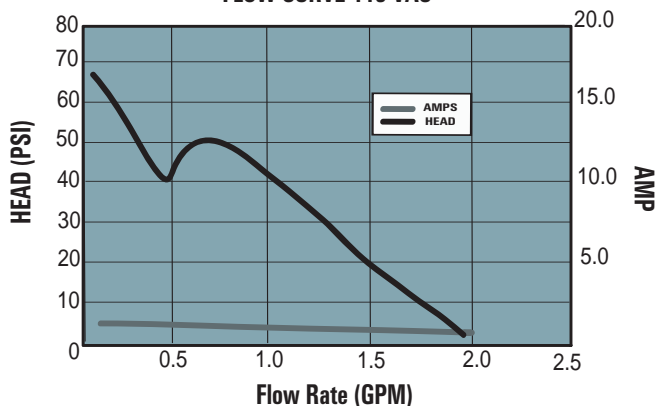

FEATURES

- Compact automatic demand pump
- Sealed pressure switch and motor
- Self-priming; pump can be located above supply tank
- Can run dry for extended periods of time without damage
- Flow rates to 2.0 GPM (7.6 l/min) and operating pressure to 50 psi (3.4 bar)

APPLICATIONS

- Small Boom and Spot Spraying
- Foam Marking
- Silage Treatment
- Estate Spraying
- Livestock and Poultry Cooling
- Dispensing
- Transfer of liquids

High Pressure Triplex Pumps (3 Piston)



Flojet Triplex High Pressure diaphragm pumps are self-priming and can run continuously for short periods of time. The higher the duty cycle, the shorter the expected life of the pump. Typical uses include transfer, delivery, spraying, cooling, filtration, dispensing, and pressure boosting.

SPECIFICATIONS

Pump Design	Motor Operated 3 Chamber diaphragm
Motor Design	Permanent Magnet DC and rectified (PMDC) AC
Voltage	12, 24 VDC 115, 230 VAC
Cycles:	50/60 Hz
Amp Draw:	9 amp max for 12 VDC 0.95 amp max for 115 VAC
Pump Head:	Glass filled Nylon
Elastomers	Diaphragm Santoprene™ Check Valve EPDM or Viton
Max. Flow Rate:	2.0 GPM (7.6 LPM)
Maximum Pressure	150 psi (10.3 bar) switch cutoff 140 psi (9.7 bar) max running pressure
Max. Liquid Temp:	40° F (4° C) Min 140° F (60° C) Max
Duty Cycle:	Intermittent
Weight	7.6 lb (3.5 Kg)
Certifications:	CE, NSF components
Port Size Inlet/outlet	3/8" NPTF

HEAD-FLOW CURVE 100 psi
FLOW RATE

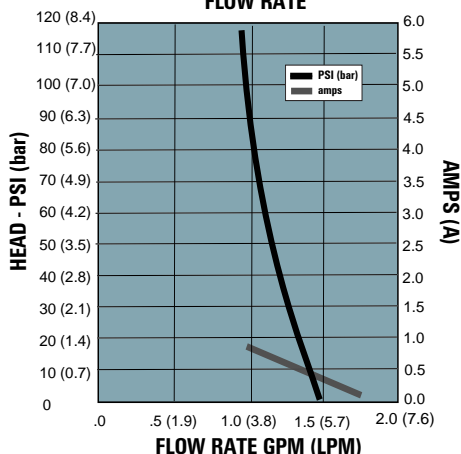

HEAD-FLOW CURVE 150 psi
FLOW RATE

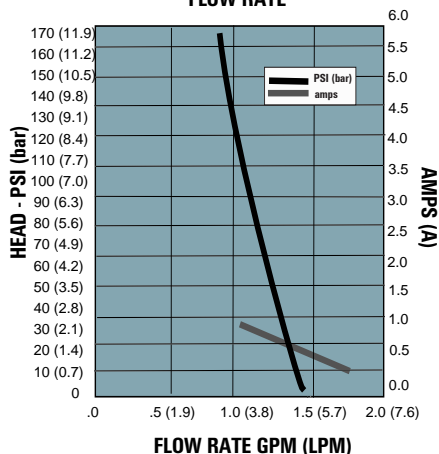

FEATURES

- Constructed from a selection of materials suitable for handling a broad range of chemicals.
- Sealed pressure switch and motor
- Self-priming; pump can be located above supply tank
- Can run dry for extended periods of time without damage
- Flow rates to 2.0 GPM (7.6 l/min) and operating pressure to 150 psi (10.3 bar)

APPLICATIONS

- Designed for wide range of applications
- Small Boom and Spot Spraying
- Silage Treatment
- Estate Spraying
- Livestock and Poultry Cooling
- Dispensing
- Transfer of liquids

Quad Sensor VSD Pumps



Solid State microcontroller and firmware allow VSD pumps to provide constant pressure within their pumping range regardless of the number or size of nozzles operating at any time. Simulates a constant city-water-pressure type supply. Soft-start feature prevents splash. Unlike conventional pumps, the VSD is very quiet and draws very little current at low flow rates. Handles variable tip nozzles from full flow to shut off as well as multi-nozzle spray bars. VSD automatically shuts off if supply voltage falls below 8 volts to protect the vehicle battery.

SPECIFICATIONS

Pump Design	Four piston diaphragm type
Open Flow	R4400-503 0-3.7 gpm (14 lpm) R4400-504 0-4.5 gpm (17 lpm)
Voltage	12-24V DC
Body Material	Polypropylene
Diaphragm Material	Santoprene
Check Valve Material	Viton
Port Size	R4400-503 1/2" hose barb straight and elbow R4400-504 3/4" hose barb straight and elbow

Motor	Permanent magnet DC totally enclosed non-vented double ball bearing thermal protection EMI filter
-------	---

Regulated Pressure	R4400-503 25 psi (1.7 bar) R4400-504 30 psi (2.1 bar)
Duty Cycle	intermittent
Suction Lift Dry	8' vertical lift nominal
Liquid Temp.	130° F (54° C)
Approvals	CSA, CE

Size	R4400-503 3.75" x 6.3" x 9.0" (95 x 160 x 228 mm) R4400-504 3.75" x 6.3" x 10.3" (95 x 160 x 261 mm)
Ship Wt.	R4400-503 4.3 lbs (2 kg) R4400-504 6.3 lbs (3 kg)

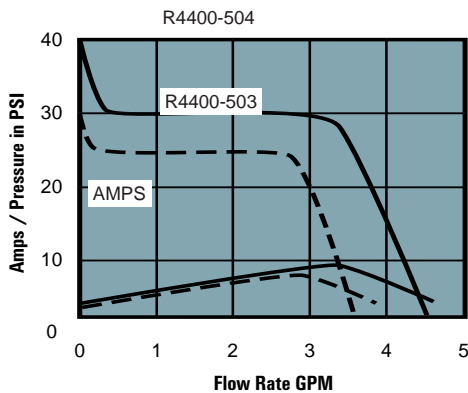

Quad Commercial Duty Pumps

Models	4300-530 4100-521	12VDC 12VDC	S/V S/V	3C 3C	SW40 No Switch
--------	----------------------	----------------	------------	----------	-------------------

Quad DC Commercial Duty

SPECIFICATIONS

Pump Design	Four piston diaphragm type
Open Flow	3.3 gpm (12.5 lpm)
Voltage	12V DC
Body Material	Polypropylene
Diaphragm Material	Santoprene
Check Valve Material	Viton
Port Size	1/2" hose barb port and Quest, see accessories
Motor	PMDC, totally enclosed non-vented, weather coating, thermal protection, metal baseplate
Pressure	30 psi maximum
Duty Cycle	Continuous
Suction Lift Dry	6' (1.8m) vertical lift
Liquid Temp.	130° F (54° C) maximum
Approvals	CE
Size	10.3" x 4.0" x 3" (261mm x 101mm x 76mm)
Ship Wt.	7 lbs (3.2 kg)

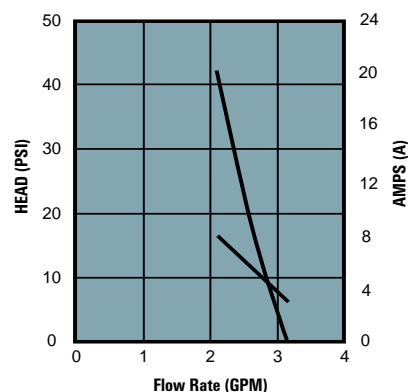

Quad AC Commercial Duty

Models	4300-529	115V AC	S/V	3C	SW40
--------	----------	---------	-----	----	------

SPECIFICATIONS

Pump Design	Four piston diaphragm type
Open Flow	3.3 gpm (12.5 lpm)
Voltage	115V AC
Body Material	Polypropylene
Diaphragm Material	Santoprene
Check Valve Material	Viton
Port Size	1/2" hose barb ports see accessories
Motor	Permanent split capacitor AC type totally enclosed fan cooled thermal protection 6' power cord with 3 prong plug
Pressure	30 psi maximum
Duty Cycle	Continuous 25 psi (1.7 bar) at 70° F (21° C)
Suction Lift Dry	8' (2.4m) vertical lift
Liquid Temp.	130° F (54° C) maximum
Approvals	CE
Size	10.9" x 5.4" x 5.7" (276mm x 137mm x 145mm)
Ship Wt.	12 lbs (5.5 kg)

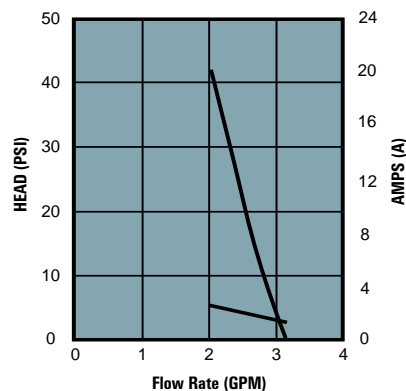

Quad Standard Duty Pumps

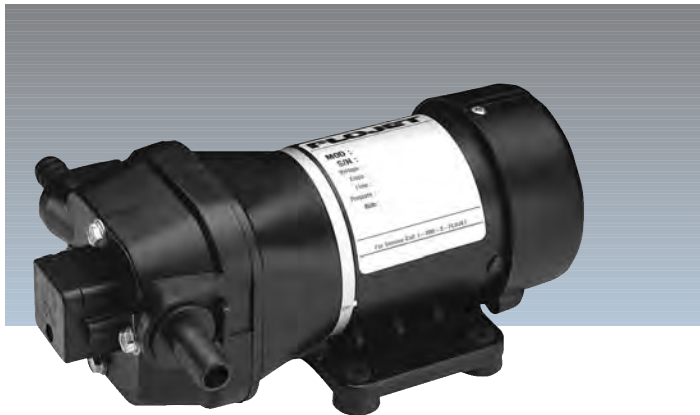

SPECIFICATIONS

Pump Design	Four piston diaphragm type
Open Flow	4.8 gpm (18.2 lpm) 3.3 gpm (12.5 lpm)
Voltage	12 or 24V DC 115V AC
Body Material	Polypropylene
Diaphragm Material	Santoprene or Geolast
Check Valve Material	Viton or EPDM
Port Size	1/2" or 3/4" hose barb see accessories
Motor	PMDC totally enclosed fan cooled
Pressure	30 psi maximum
Duty Cycle	Intermittent 30 psi (2.1 bar) at 70° F (21° C) continuous 15 psi (1.0 bar) at 70° F (21° C)
Suction Lift Dry	3 cam 8' (2.4m) vertical lift 2 cam 6' (1.8m) vertical lift
Liquid Temp.	130° F (54° C) maximum
Size	9.0" x 3.2" x 3.8" (228 x 81 x 96 mm)
Ship Wt.	4 lbs (1.8 kg)

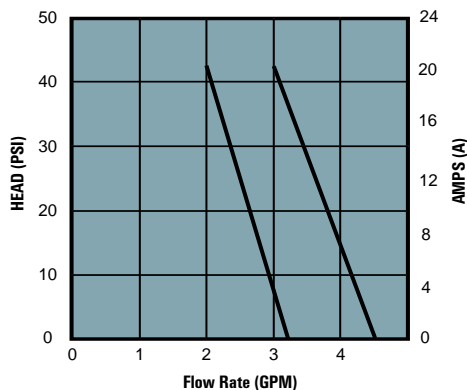

PUMP SPECIFICATIONS									
Model	Supply Voltage	Diaphragm Material	Check Valve	Open Flow	Cam Size	Off Pressure	Motor Type	Port Fittings	Thermal Protection
4100-143	12V DC	Santo	EPDM	4.5	3	--	TEFC	3/4" Hose Barb	Yes
4100-502	12V DC	Santo	Viton	4.5	3	--	TEFC	3/4" Hose Barb	Yes
4100-142	12V DC	Santo	EPDM	3.2	2	--	TEFC	1/2" Hose Barb	No
4100-505	12V DC	Santo	Viton	3.2	2	--	TEFC	1/2" Hose Barb	No
4300-143	12V DC	Santo	EPDM	4.5	3	45	TEFC	3/4" Hose Barb	No
4300-504	12V DC	Santo	Viton	4.5	3	45	TEFC	3/4" Hose Barb	No
4300-142	12V DC	Santo	EPDM	3.2	2	45	TEFC	1/2" Hose Barb	No
4300-500	12V DC	Santo	Viton	3.2	2	45	TEFC	1/2" Hose Barb	No
4300-342	24V DC	Santo	EPDM	3.2	2	45	TEFC	1/2" Hose Barb	No
4300-343	24V DC	Santo	Viton	4.5	3	45	TEFC	3/4" Hose Barb	No
4100-343	24V DC	Santo	EPDM	4.5	3	--	TEFC	3/4" Hose Barb	No
4300-513	115V AC	Geolast	Buna	3.2	2	45	TEFC	1/2" Hose Barb	No

6000 Series Pumps



6000 Series pumps are designed for a wide range of applications and are constructed from a selection of materials suitable for handling a broad range of chemicals. The 5 chamber high flow pumps are self-priming and can run dry without harm. They are intended for duty cycles but can be run continuously for short periods of time. The higher the duty cycle, the shorter the expected life of the pump. typical uses include transfer, delivery, spraying, cooling, filtration,

SPECIFICATIONS

Pump Design	5 chamber diaphragm
Motor Design	Permanent Magnet DC
Voltage	12, 24 VDC
Motor rating:	IP 54 (splash proof)
Amp Draw:	13.5 amp @ 10 psi for 12 VDC 6.8 amp @ 10 psi for 115 VAC
Fuse Size (A):	30 amp for 12 VDC 15 amp for 24 VDC
Pump Body:	Glass filled Nylon
Elastomers	Diaphragm Santoprene™ Check Valve EPDM
Max. Flow Rate:	7.5 GPM (28 LPM)
Maximum Pressure:	60 psi (4.2 bar)
Liquid Temp:	40° F (5°C) max 140° F (60° C) max
Duty Cycle:	Intermittent
Weight	9.5 lb (4.3 Kg) max
Certifications:	CE
Port Size Inlet/outlet	3/4" HB

FEATURES

- Breakthrough performance for high flow and pressure applications
- 7.5 GPM flow
- AC and DC motor options
- Self priming, runs dry
- Low amps at low flow

HEAD-FLOW CURVE (12V & 24V)

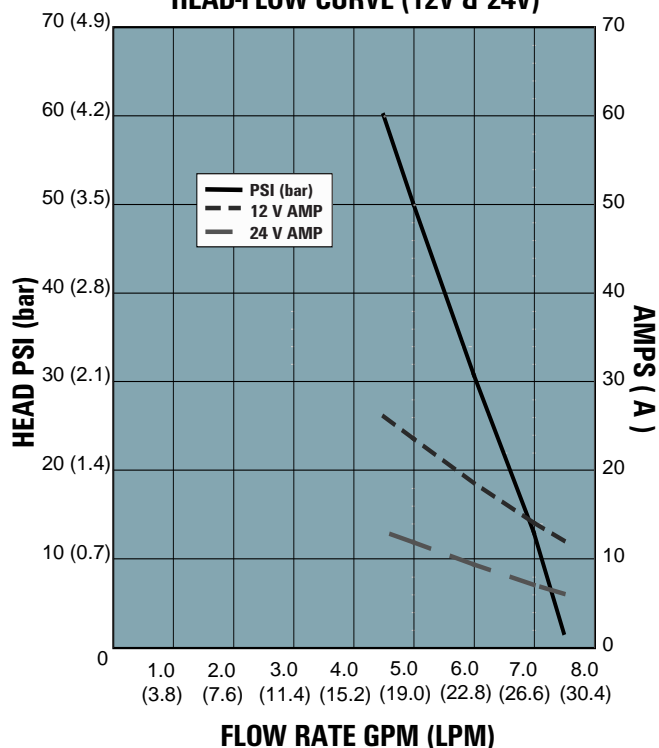

G57 Air-Operated Diaphragm Pumps

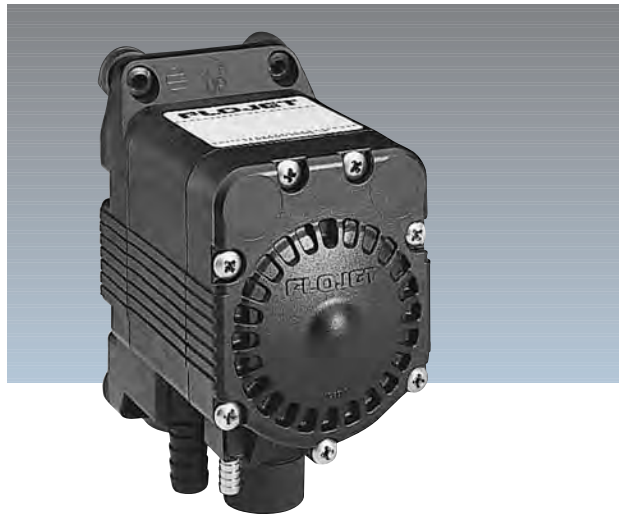

Innovative compact design features a patented shuttle valve that eliminates stalling. Chemically resistant Polypropylene body with a choice of Santoprene or Viton elastomers. Over-size exhaust muffler provides quiet operation. Quick disconnect liquid and gas port fittings for easy installation. Do not pump gasoline or other flammable liquids.

SPECIFICATIONS

Rated Flow	3.5 gpm (13.3 lpm)
Max Open Flow	5.0 gpm (19.0 lpm)
Gas/Air Pressure	20 to 100 psi (1.4 to 7 bar)
Gas/Air Supply	clean, dry, oil free
Body Material	Polypropylene
Diaphragm Material	Santoprene or Viton
Check Valve Material	Santoprene or Viton
Spring Material	Hastelloy
Liquid Port Size	3/8" or 1/2" or 3/4" barb
Gas Port Size	1/4" poly or brass barb
Dry Prime	15 ft (4.5m)
Wet Prime	20 ft (6.1m)
Liquid Temp Range	40-120° F (4-49° C)
Liquid Inlet Pressure	30 psi (2.1 bar) Max
Maximum Air Pressure	100 psi (6.9 bar)
Ship Wt.	1.2 lbs (.6 kg)

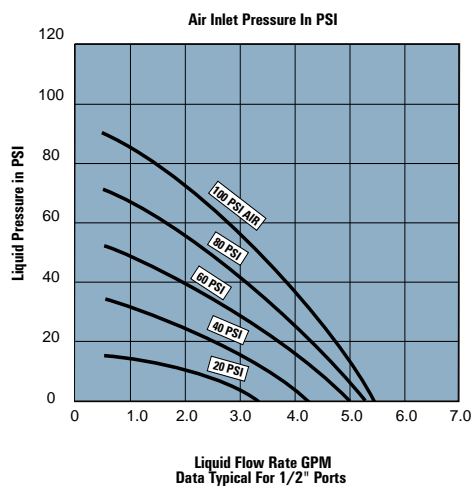

Model	Liquid Elastomer	Gas Ports	Muffler Ports	Size
G575205	Santo	3/8" plastic	1/4" brass barb	Large
G575215	Santo	1/2" plastic	1/4" brass barb	Large
G575225	Santo	3/4" plastic	1/4" brass barb	Large
G575208	Santo	3/8" plastic	1/4" plastic barb	Large
G575218	Santo	1/2" plastic	1/4" plastic barb	Large
G575228	Santo	3/4" plastic	1/4" plastic barb	Large
G573205	Viton	3/8" plastic	1/4" brass barb	Large
G573215	Viton	1/2" plastic	1/4" brass barb	Large
G573225	Viton	3/4" plastic	1/4" brass barb	Large
G573208	Viton	3/8" plastic	1/4" plastic barb	Large
G573218	Viton	1/2" plastic	1/4" plastic barb	Large
G573228	Viton	3/4" plastic	1/4" plastic barb	Large



5100 Air-Operated Diaphragm Pumps

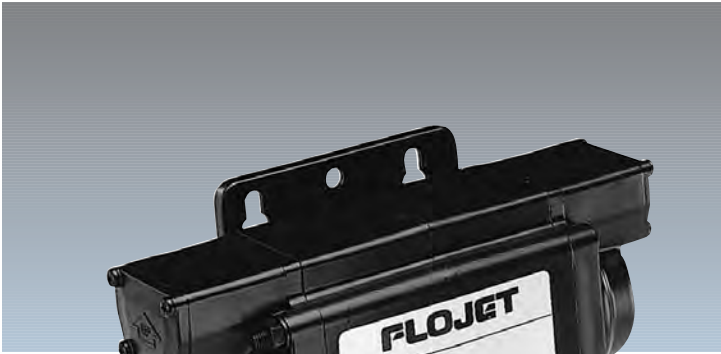

Flojet air operated diaphragm pumps offer excellent self-priming capability. Pumps can be located above the supply tank. Suction-side foot valve is recommended for best operation. Liquid pressure is regulated by supply air pressure. No bypass or pressure relief plumbing is necessary. Choice of Santoprene, Buna, or Viton elastomers provide a wide range of chemical compatibility. Quick disconnect liquid and gas port fittings provided for easy installation. Do not pump gasoline or other flammable liquids.

SPECIFICATIONS

Rated Flow	1 gpm (3.8 lpm)
Max Open Flow	1.9 gpm (7.2 lpm)
Gas/Air Pressure	20 to 75 psi (1.4 to 5.3 bar)
Gas/Air Consumption	.45 CFM at 40 psi at 1 gpm .58 CFM at 60 psi at 1 gpm
Gas/Air Supply	clean, dry, oil free
Liquid Inlet Pressure	15 psi (1 bar) max
Body Material	Acetal Copolymer
Diaphragm Material	Santoprene, Buna or Viton
Check Valve Material	Santoprene, Buna or Viton
Port Size	liquid ports 3/8" barb gas ports 1/4" barb
Dry Prime	28 ft (8.5m)
Wet Prime	32 ft (9.8m)
Max Liquid Temp	120° F (49° C)
Size	4 1/32" x 2 3/8" x 6" (102 x 60 x 152 mm)
Ship Wt.	.6 lbs (.3 kg)

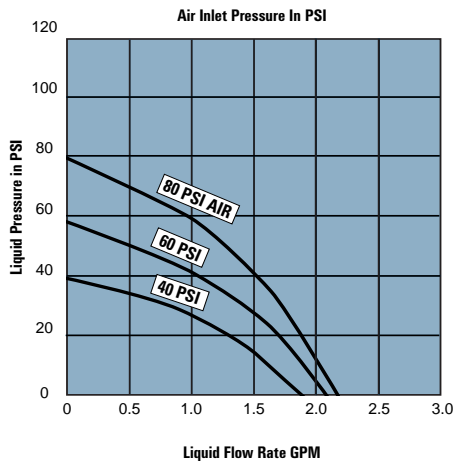

Model	Elastomer	Liquid Ports	Gas Ports
5100-010	Buna	3/8" plastic barb	1/4" plastic barb
5100-020	Viton	3/8" plastic barb	1/4" plastic barb
5100-040	Santo	3/8" plastic barb	1/4" plastic barb

FLOJET®





17830-1012

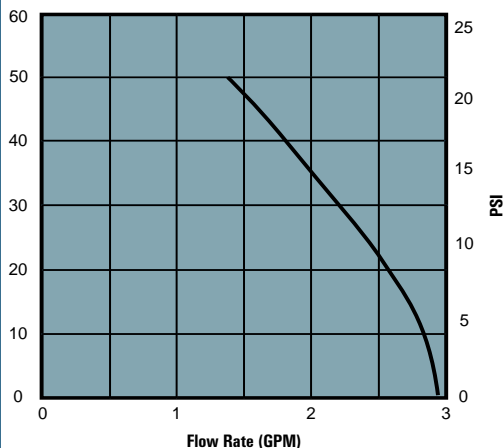

17830 Reversible DC Water Puppy

Models 17830-1012

Especially suited for viscous fluids and engine oil transfer where self-priming and 3 gpm flow is required. Pump oil from crankcase to storage container, and from storage container to waste container automatically using the manual flow reverse switch. No need to remove or re-attach hoses to reverse oil flow direction. Oil temperature should be 100-140°F. Use 12V DC from vehicle battery. Do not pump gasoline or other flammable liquids. DO NOT RUN DRY.

SPECIFICATIONS

Open Flow	3 gpm (11.4 lpm)
Voltage	12V DC
Body Material	bronze
Impeller Material	Nitrile
Shaft Material	stainless steel
Shaft Seal	Buna lip type
Port Size	3/8" NPT(F)
Motor	PMDC, TENV with manual reverse switch 10 amps nominal 15 amps fuse
Approvals	CE
Maximum Pressure	8.7 psi or 20 ft of lift
Prime Dry, Wet	3-4 ft (.9-1.2 m), 15-20 ft (4.6-6.1 m)
Liquid Temp.	45-180°F (7-82°C) Nitrile
Size	4 7/16" x 3 1/4" x 7 7/8" (113 x 83 x 200 mm)
Ship Wt.	9 lbs (4.1 kg)



18660-0121

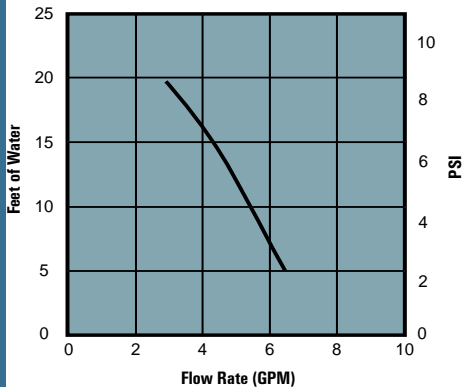

18660 DC Water Puppy

Models 18660-0121 Neoprene impeller
18660-0123 Nitrile impeller

For general transfer pumping where self-priming, 6 gpm flow and debris tolerance are required. Use optional oil-resistant nitrile impeller 6303-0003 if oil or diesel fuel are present. Do not pump gasoline or other flammable liquids. DO NOT RUN DRY.

SPECIFICATIONS

Open Flow	6.3 gpm (24 lpm)
Voltage	12V DC
Body Material	bronze
Impeller Material	Neoprene or Nitrile
Shaft Material	stainless steel
Shaft Seal	lip type
Shaft Seal Material	Nitrile
Port Size	1/2" NPT(F) 3/4" male garden hose adapter
Motor	PMDC, TENV 8.0 amps nominal 15 amps fuse
Maximum Pressure	8.7 psi or 20 ft of lift
Prime Dry, Wet	2-4 ft (.6-1.2 m), 15-20 ft (4.6-6.1 m)
Liquid Temp.	45-180°F (7-82°C) Neoprene
Size	3 3/8" x 4 3/4" x 6 1/2" (86 x 121 x 165 mm)
Ship Wt.	4.5 lbs (2. kg)



18670 Commercial Duty DC Water Puppy

Model	18670-0123	12V	Nitrile Seal
	18670-0923	12V CE	Nitrile Seal
	18670-0943	24V CE	Nitrile Seal



18670-0123

Commercial Duty Water Puppy has 25% more flow than the standard model and a heavy duty PMDC motor. For general transfer pumping where self-priming, 8 gpm flow and debris tolerance are required. Oil-resistant nitrile impeller is standard. Do not pump gasoline or other flammable liquids. DO NOT RUN DRY.

SPECIFICATIONS

Open Flow	8 gpm (30.4 lpm)
Voltage	12 or 24V DC
Body Material	bronze
Impeller Material	Nitrile
Shaft Material	316 stainless steel
Shaft Seal	lip type
Port Size	1/2" NPT(F) and 1" hose barb 3/4" male garden hose adapter
Motor	PMDC, TENV Amp Draw 11.5 amp at 12V, 5 amp at 24V Fuse Size 20 amp for 12V, 10 amp for 24V
Maximum Pressure	8.7 psi or 20 ft of lift
Prime Dry, Wet	4-6 ft (1.2-1.8 m), 15-20 ft (4.6-6.1 m)
Liquid Temp.	50-180°F (10-82°C) Nitrile
Maximum Pressure	8.7 psi or 20 ft of Head
Size	3" x 4 3/4" x 6 7/8" (76 x 120 x 175 mm)
Ship Wt.	6.0 lbs (2.7 kg)

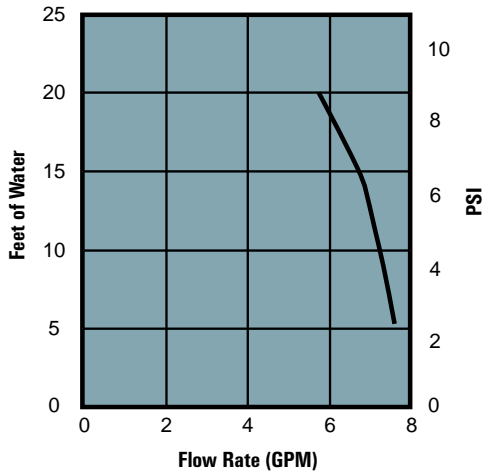



11810-0003

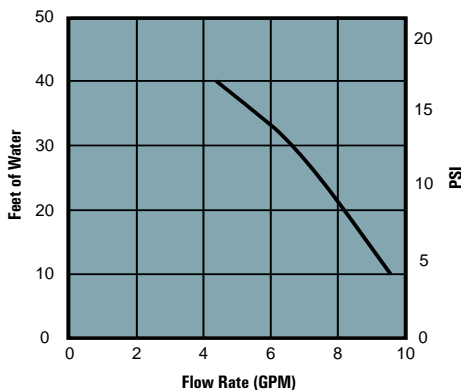

6050-0003

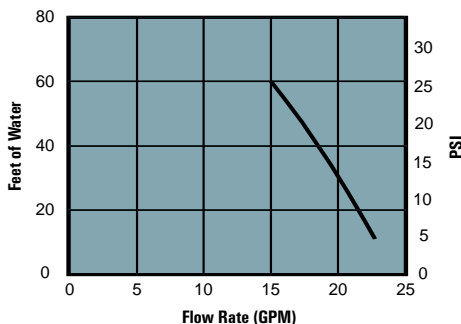

11810 Bronze AC Utility Pump

Models	11810-0003	Nitrile impeller	ODP motor	Nitrile seal
	11810-0011	Neoprene impeller	TEFC motor	Nitrile seal
	11810-0013	Nitrile impeller	TEFC motor	Nitrile seal

For general transfer pumping where self-priming, 10 gpm flow, debris tolerance and portable 115V AC operation is desired. Nitrile for oil based products. Neoprene for water and general purpose pumping. Do not pump gasoline or other flammable liquids. Do not run dry. Motor is not explosion proof.

SPECIFICATIONS

Open Flow	10 gpm (38 lpm)
Voltage	115V AC 60Hz single phase
Body Material	bronze
Impeller Material	Nitrile
Shaft Material	316 stainless steel
Shaft Seal	lip type
Shaft Seal Material	Nitrile
Port Size	1/2" NPT(F) and 3/4" male garden hose thread
Motor	1/3 hp, TEFC or ODP AC induction type 8 ft power cord with 3 prong grounded plug thermal overload protected 7 amps nominal 10 amp fuse
Maximum Pressure	17 psi, 39 ft of Head
Prime Dry, Wet	8 - 10 ft, 16 - 20 ft
Liquid Temp.	45-180°F (7-82°C) Neoprene 50-180°F (10-82°C) Nitrile
Size	7 3/4" x 7 1/4" x 10 1/2" (197 x 184 x 267 mm)
Ship Wt.	20 lbs (9.1kg) ODP, 25 lbs (11.3kg) TEFC

6050 Bronze AC Utility Pump

Models	6050-0003	ODP Motor
	6050-0013	TEFC Motor

For general transfer pumping using 115V AC power where self-priming, 23 gpm flow and debris tolerance are required. Oil-resistant nitrile impeller is standard. Do not pump gasoline or other flammable liquids. DO NOT RUN DRY.

SPECIFICATIONS

Open Flow	23 gpm (87 lpm)
Voltage	115V AC 60Hz single phase
Body Material	bronze
Impeller Material	Nitrile
Shaft Material	316 stainless steel
Shaft Seal	lip type
Shaft Seal Material	Nitrile
Port Size	1" NPT(F)
Motor	3/4 Hp TEFC or ODP AC induction type 8 ft. power cord with 3 prong grounded plug thermal overload protected
Maximum Pressure	26 psi or 60 ft lift
Prime Dry, Wet	8-10 ft (2.4-3 m), 20-22 ft (6.1-6.7 m)
Liquid Temp.	50-180°F (10-82°C)
Ship Wt.	35.5 lbs (16.1 kg)
Size	8 19/32" x 7 3/4" x 13 1/32" (218 x 197 x 331 mm)



NEW 23920 Extended Run Dry DC Flexible Impeller Pump

Models	23920-9403	12VDC	8 gpm
	23920-9213	12VDC	11 gpm

For general purpose pumping where self-priming and extended run dry capability are required. Liquid stored in the specially designed pumphead provides 10 minutes or more of run dry operation after liquid supply tank is empty. Heavy duty 12V DC motor. Upgraded carbon-ceramic mechanical shaft seal standard. Do not pump gasoline or other flammable liquids.



23920-9403

SPECIFICATIONS

Open Flow	8 or 11 gpm (30 or 42 lpm)		
Voltage	12V DC		
Body Material	bronze		
Impeller Material	Nitrile		
Shaft Material	stainless steel		
Shaft Seal	mechanical, Carbon Ceramic/Nitrile		
Port Size	3/4" NPT(F)		
Motor	PMDC, TENV		
	23920-9403	15 amp fuse	
	23920-9213	25 amp fuse	
Liquid Temp.	45-180°F (7-82°C)		
Maximum Pressure	8 psi, 19 ft of lift		
Dry Prime	23920-9403	3-4 ft,	23920-9213 6-8 ft
Size	23920-9403	7 1/2" x 4 3/4" x 3 1/2" (190 x 121 x 89 mm)	
	23920-9213	8 1/2" x 4 3/4" x 3 1/2" (216 x 121 x 89 mm)	
Ship Wt.	23920-9403	8.2 lbs (4 kg)	
	23920-9213	9.7 lbs (3.4 kg)	

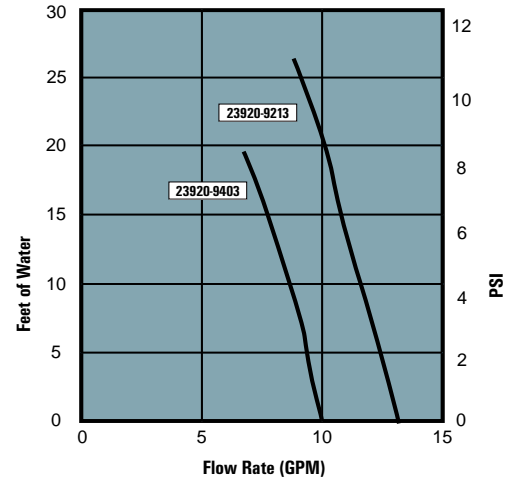

30140-0003

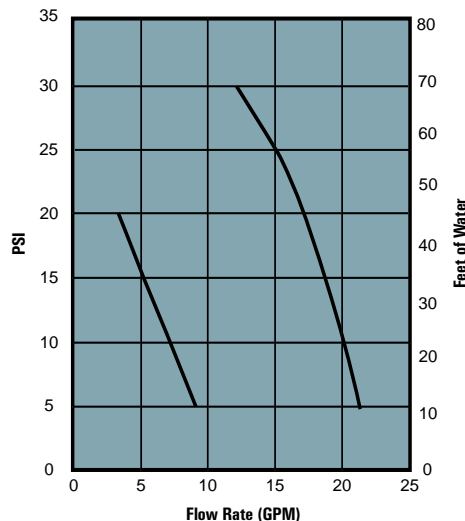

30140 & 30180 Run Dry AC Flexible Impeller Pump

Models	30140-0003	9 gpm
	30180-0003	23 gpm

For general transfer pumping where self-priming, debris tolerance and extended run dry capability are required. Liquid stored in the specially designed pumphead provides 10 or more minutes of operation after supply tank is empty. Oil-resistant nitrile impeller is standard. Do not pump gasoline or other flammable liquids. EXTENDED RUN DRY CAPABILITY.

SPECIFICATIONS

Open Flow	30140 9 gpm (34 lpm)	30180 23 gpm (87 lpm)
Voltage	115V AC 60Hz single phase	
Body Material	bronze	
Impeller Material	Nitrile	
Shaft Material	316 stainless steel	
Shaft Seal	Nitrile, lip type	
Port Size	1" NPT(F) 30140	1 1/2" NPT(F) 30180
Motor	1/3 Hp capacitor start type, ODP, 8 ft. power cord 3 prong grounded plug, thermal overload protected	
	7 amps 30140,	11 amps 30180, fuse
	10 amps 30140,	15 amps 30180, fuse
Maximum Pressure	30140 20 psi or 46 ft lift	30180 30 psi or 69 ft lift
Prime Dry, Wet	30140 8-10 ft (2.4-3 m)	30180 15-22 ft (4.6-6.7 m)
Liquid Temp.	50-180° F (10-82° C)	
Size	30140 7 9/16" x 7 3/8" x 10 1/8" (192 x 187 x 257 mm)	30180 8 1/2" x 8 1/8" x 11 11/16" (216 x 206 x 297 mm)
Ship Wt.	30140 23.0 lbs (10.4 kg)	30180 31.0 lbs (14.1 kg)



18590-1000

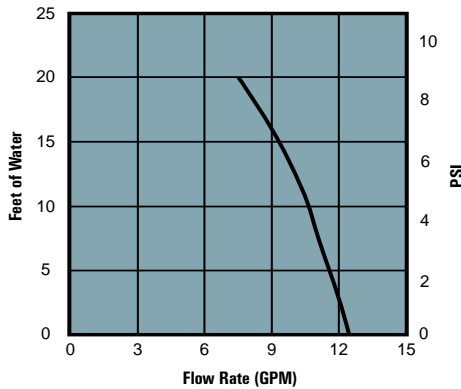

18690-0000

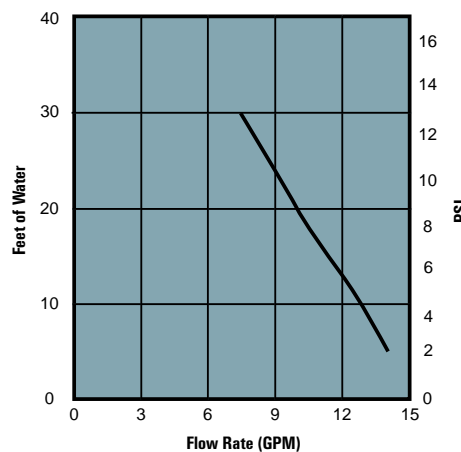

18590 Macerator Run Dry DC Flexible Impeller Pump

Model	18590-1000	12V
	18590-1090	12V CE

Run-dry protected macerator pump combines a self-priming flexible impeller pump with a high speed macerator blade to grind soft waste and debris down to 1/8" diameter for pumping. Ideal for animal waste and plant material slurry. Not for pumping stringy objects such as rags or solid objects like large fruit pits. Can empty a 30-gallon waste tank in approximately 3 minutes. Designed for intermittent operation. Run-dry protection circuit turns pump off after approximately 20 seconds of dry-run operation. Reactivation after run-dry shutdown occurs automatically the next time the pump is turned on. Reliance on the run-dry protection circuit to turn the pump off will significantly shorten impeller life. Do not pump gasoline or other flammable liquids. DO NOT RUN DRY.

SPECIFICATIONS

Open Flow	12 gpm (46 lpm)
Voltage	12V DC
Body Material	Polypropylene
Impeller Material	Nitrile
Shaft Material	stainless steel
Macerator Blade	stainless steel
Shaft Seal	Nitrile lip type
Inlet Port Size	1 1/2" NPT(M) or 1 1/2" hose barb
Outlet Port Size	1" Hose Barb
Motor	PMDC, TENV run dry protected 14 amps nominal 20 amps Fuse
Maximum Pressure	8.7 psi or 20 ft of lift
Prime Dry	4 ft (1.2 m)
Liquid Temp.	45-120° F (7-49° C)
Size	3 5/8" x 4 3/4" x 11 3/8" (92x 121 x 289 mm)
Ship Wt.	5.0 lbs (2.3 kg)

18690 Macerator AC

Model	18690-0000	115V
-------	------------	------

Pump combines a self-priming flexible impeller pump with a high speed macerator blade to grind soft waste and debris down to 1/8" diameter for pumping. Ideal for animal waste and plant material slurry. Not for pumping stringy objects such as rags or solid objects like large fruit pits. Can empty a 30-gallon waste tank in approximately 3 minutes. Designed for intermittent operation. Do not pump gasoline or other flammable liquids. DO NOT RUN DRY.

SPECIFICATIONS

Open Flow	14 gpm (53 lpm)
Voltage	115V AC
Body Material	Polypropylene
Impeller Material	Nitrile
Shaft Material	stainless steel
Macerator Blade	cast bronze
Shaft Seal	Nitrile lip type
Inlet Port Size	1 1/2" NPT(M) or 1 1/2" hose barb
Outlet Port Size	1" Hose Barb
Motor	TENV, AC induction type, thermal overload protected nominal amp draw 7.2 amps
Maximum Pressure	13 psi or 30 ft of lift
Prime Dry	4 ft (1.2 m)
Liquid Temp.	45-120° F (7-49° C)
Size	14 7/8" x 7 1/4" x 8" (378 x 184 x 203 mm)
Ship Wt.	19 lbs (8.6 kg)

Oil Change System

Flat Tank Oil & Fluid Changing System

The Oil & Fluid changing System reduces time for and simplifies the fluid changing process. It is ideal for Automotive and heavy duty diesel service, construction, agricultural and industrial vehicles, boats and RV's

- 3 1/2 gallon (13 liter) self-contained unit
- Convenient Dipstick suction tube
- Powerful 12 VDC motor makes oil changing quick & simple
- 7-foot (2.1 m) electrical wire for easy usage
- Battery clamp leads and an on-off switch to make the pumping process simpler and easier



178601012

SPECIFICATIONS

Model	178601012
Pump Body:	Polypropylene
Diaphragm:	Geolast [®] , oil resistant
Valves:	Viton [®] , oil resistant
Motor:	12 VDC with integral power switch
Receiver:	Plastic with 14 quart max. capacity tank
Weight:	3.5 lb (1.6 Kg)

Accessories and Fittings



Inlet Strainers 1745 Series PETG Viton

- New PETG cover for improved chemical resistance.
- Viton o-ring is standard.
- Low profile design for space saving installation.
- Very strong reinforced plastic base with clear cover.
- Wide variety of port configurations from 3/8" to 3/4."

SPECIFICATIONS

Materials	Base	Polypropylene, black
	Cover	PETG, Glycol-modified polyester terephthalate
Temperature	Screen	Stainless Steel 40 mesh
	O-rings	Viton

Styles Available

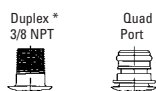

Model No.	Description
01745-010	Quad x 3/4" hose barb, Viton o-ring, PETG cover
01745-012	Quad x 1/2" hose barb, Viton o-ring, PETG cover
01745-023	3/8" NPT (M) x 3/8" hose barb, Viton o-ring, PETG cover

*3/8" NPT (M) fits all Duplex II models

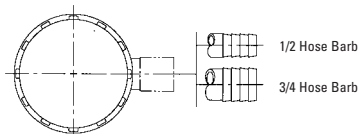

Inlet Strainer
(Plugs into Quad pump port)

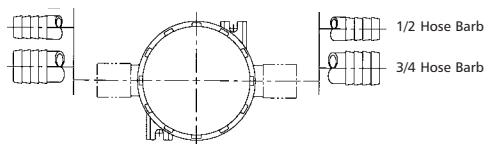
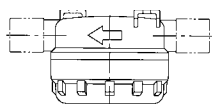

In-Line Strainer

Model No.	Description
01745-000	Inline strainer, 3/4" hose barb x 3/4" hose barb, Viton o-ring, PETG cover
01745-002	Inline strainer, 1/2" hose barb x 1/2" hose barb, Viton o-ring, PETG cover

Electric Pump Fittings Nylon Barbed Straight/Elbow

For use with all Pentaflex Series (3/8" NPT only) and Duplex II Series Pumps (3/8" NPT only).

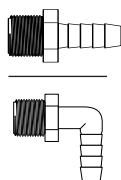

Part No. Straight	Part Number Elbow	Description
91010-032	91010-033	3/8" NPT Male x 1/4" Barb
91010-004	91010-003	1/4" NPT Male x 3/8" Barb
91010-002	91010-001	3/8" NPT Male x 3/8" Barb
91010-034	91010-025	1/4" NPT Male x 3/8" Barb
91010-006	91010-005	3/8" NPT Male x 1/2" Barb
91010-053	91010-052	1/4" NPT Male x 1/4" Barb

Plastic (Polypropylene Body, Viton O-ring) Inlets & Outlets

For use with all Quad Series Pumps.

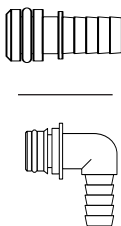

Part No. Straight	Description
20381-015	Quad x 1/2" hose barb straight, Viton o-ring
20381-033	Quad x 5/8" hose barb straight, Viton o-ring
20381-014	Quad x 3/4" hose barb straight, Viton o-ring
20381-017	Quad x 1/2" hose barb elbow, Viton o-ring
20381-018	Quad x 3/4" hose barb elbow, Viton o-ring
20381-032	Quad x 3/4" garden hose adapter, Viton o-ring

Other Elastomers Available
Packaged 2 per bag.
ALSO AVAILABLE IN 3/8" & 1/2" NPT (M).

Gas Pump Liquid Fittings Stainless Steel Inlets & Outlets

For use with all 5100 Series Pumps.

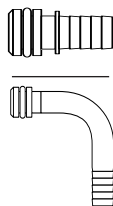

Part No. Straight	Part Number Elbow	Description
20324-030	20607-100	1/4" Hose Barb
20325-030	20608-100	3/8" Hose Barb
20606-100		1/2" Hose Barb

Gas Pump Air Fittings

Brass CO2/Air Inlets with Shutoff Valve

For use with all 5100 and G57 Series Pumps.

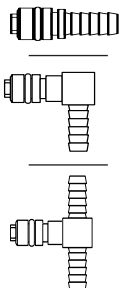

Part No.	Description
01510-000	1/4" Hose Barb, Straight
01520-000	1/4" Hose Barb, Tee
01521-000	1/4" Hose Barb, Elbow

Plastic (Celcon) CO2/Air Inlets

For use with all 5100 and G57 Series Pumps.



Part No.	Description
20325-033	1/4" Hose Barb, Straight

CHEMICAL RESISTANCE TEST DATA

AG CHEMICAL	ELASTOMER					
	EPDM (Com)	EPDM (FDA)	EPDM (Fab)	SANTO	VITON	BUNA
Diazinon	C	C	C	B	A	C
Chickweed Killer	A	A	A	A	A	A
Triox Veg Killer	C	C	C	C	B	C
Round-Up Conc	A	A	A	A	A	A
Sevin	A	A	A	A	A	B
Malathion	A	C	B	A	B	C
Spectracide	A	A	A	A	A	A
Ortho Weed-B-Gon	A	A	A	A	A	A
Ortho Weed & Grass Killer	A	A	A	A	A	A
Home Orchard Spray	A	A	A	A	A	B
Lasso MT	A	A	A	A	A	A
Round-Up Super Conc. Grass & Weed Killer	A	A	A	A	A	A
Wipe-Out Weed Killer	A	A	A	A	A	A
Lasso EC	A	B	A	A	B	C
Ortho Malathion 50 P	A	C	B	A	B	C
Super K-Gro (Dursban)	C	C	C	C	A	C
Ortho Liquid Sevin	A	A	A	A	A	A
2,4-D Amine 4	A	A	A	A	A	A
Dursban 4E	C	C	B	B	A	C
Dursban 2E	C	C	B	C	A	C
Dow Elanco 2,4,D Bee	C	B	A	B	A	C
Lorsban 4E	B	C	B	B	A	C
Dursban 50W	A	A	A	A	A	A

CARRIER

Acetone	A	A	A	A	C	C
Xylene	C	C	C	C	B	C
Kerosene	C	C	C	C	A	B

A - No Significant Effect

B - Moderate Effect, Generally Satisfactory

C - Major Effect, Not Satisfactory